

CARTA

DESIGNED BY ÉRIC BARON

Minimaliste et fonctionnelle, *Carta* s'impose par son design intemporel et sa finesse maîtrisée. Son tube lumineux pivote à 360° sans butée, offrant une liberté d'orientation infinie. Aguerrie à un usage intensif, elle incarne l'élégance durable selon CVL.











Minimalist and functional, *Carta* stands out for its timeless design and refined elegance. Its luminous tube rotates 360° without restriction, offering infinite freedom of orientation. Built to withstand intensive use, it embodies CVL's vision of lasting elegance.



Carta 15 SN

© CVL

Finitions
Finishes

| | | | | |
|--|---|---|---|---|
|  Laiton satiné SB Satin brass |  Graphite satiné SG Satin graphite |  Nickel satiné SN Satin nickel |  Cuivre satiné SC Satin copper |  Bronze BZ Bronze |
|  Laiton poli PB Polished brass |  Graphite poli PG Polished graphite |  Nickel poli PN Polished nickel |  Cuivre poli PC Polished copper | |

[Nuancier – Finish options](#)

Matériaux
Materials

| | |
|------------------------------|---|
| Laiton massif Solid brass | Diffuseur polycarbonate Polycarbonate diffuser |
|------------------------------|---|

Source
Lamping

Valeurs nominales
Nominal values

Applique encastrée – Recessed wall light

| | | | | | |
|----------------|--------|---------|----|----------------------------|---------------------|
| LED intégrée | 144 lm | 2700° K | 3W | Alimentation intégrée | Interrupteur ON/OFF |
| Integrated LED | 144 lm | 2700° K | 3W | Int. power supply included | Switch ON/OFF |

Applique encastrée + USB-C – Recessed wall light + USB-C

| | | | | | |
|----------------|--------|---------|----|----------------------------|---------------------|
| LED intégrée | 144 lm | 2700° K | 3W | Alimentation intégrée | Interrupteur ON/OFF |
| Integrated LED | 144 lm | 2700° K | 3W | Int. power supply included | Switch ON/OFF |

Designer

Éric Baron



Détail Carta BZ

CARTA 15

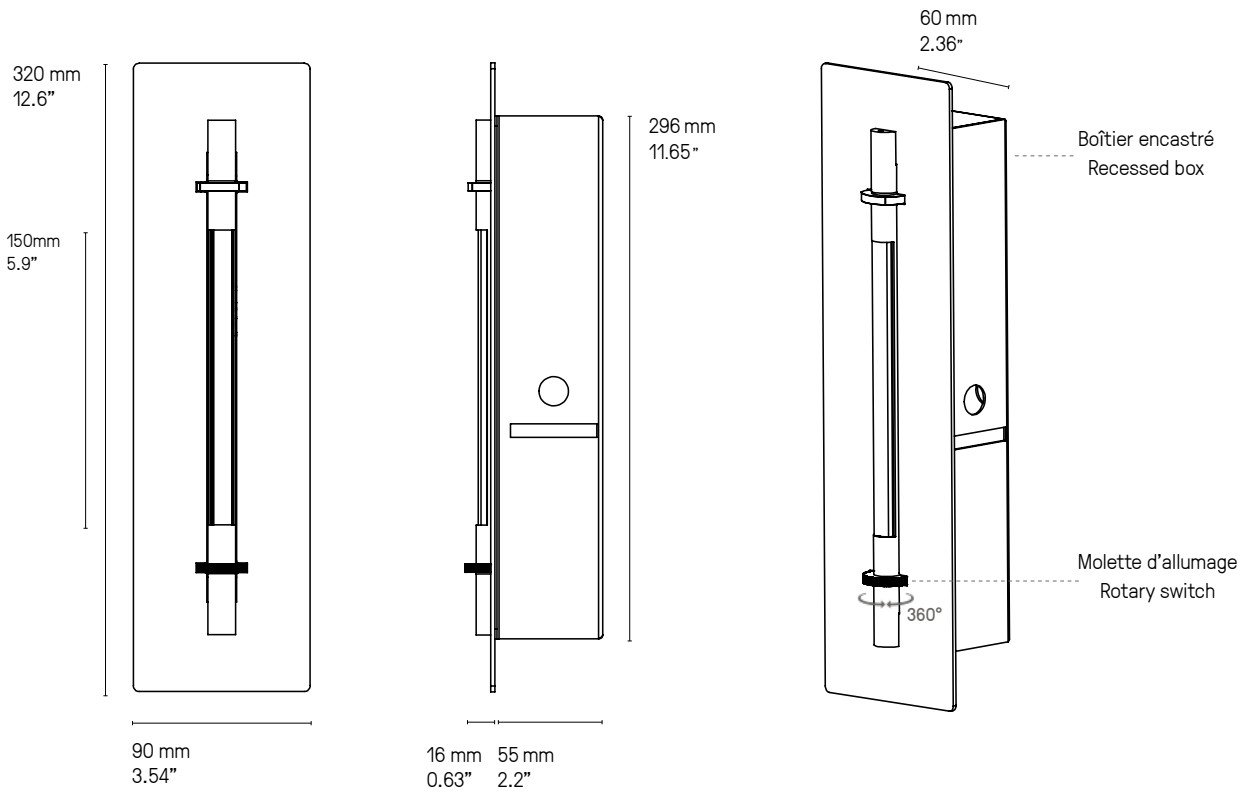

Carta 15 BZ



Carta 15 SN



Carta 15 SB



Carta+ USB-C SN

© CVL

CARTA 15 + USB-C

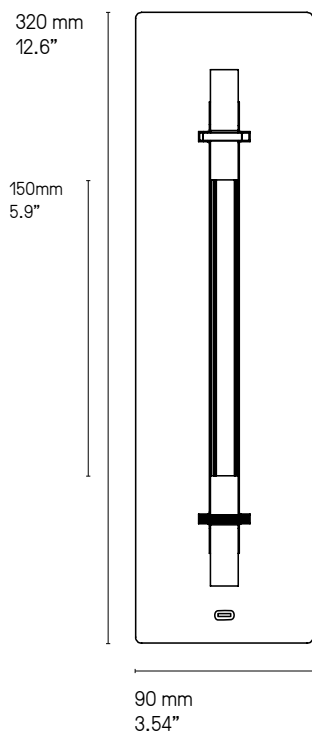

Carta + USB-C BZ

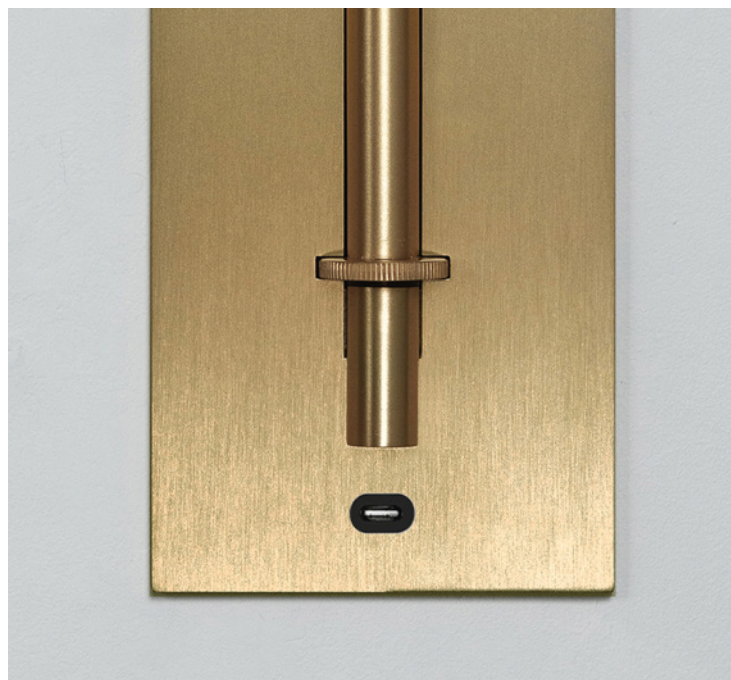

Détail Carta + USB-C SB

NUANCIER - FINISH OPTIONS 2026



LAITON - BRASS

- | | | | | |
|------------------------------------|---|-------------------------------------|-------------------------------------|-----------------------|
| ① Laiton satiné SB Satin brass | ② Graphite satiné SG Satin graphite | ③ Nickel satiné SN Satin nickel | ④ Cuivre satiné SC Satin copper | ⑨ Bronze BZ Bronze |
| ⑤ Laiton poli PB Polished brass | ⑥ Graphite poli PG Polished graphite | ⑦ Nickel poli PN Polished nickel | ⑧ Cuivre poli PC Polished copper | |

ABAT-JOURS - LAMPSHADES



AUTRES - OTHERS

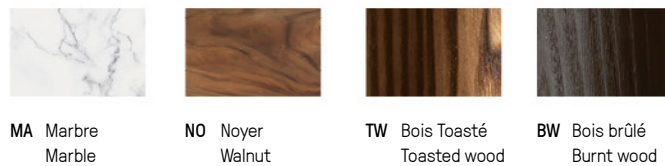

VERRERIE - GLASS



CÂBLES - CABLES

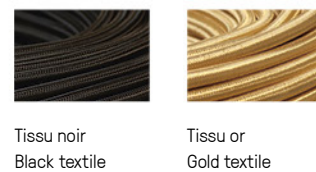

TEL. +33 (0) 2 41 32 67 54 EMAIL : CONTACT@CVL-LUMINAIRES.FR

WWW.CVL-LUMINAIRES.FR