



# COUTURE

DESIGNED BY HERVÉ LANGLAIS

Discrète et raffinée, *Couture* est une petite lampe à poser dont l'abat-jour est tout simplement boutonné sur sa tige courbée en laiton.

Sa silhouette toujours changeante, à l'élégance classique, en fait une pièce maîtresse pour un intérieur.



Discrete and refined, *Couture* is a small table lamp with a shade that is simply buttoned to its curved brass stem.





Its ever-changing profile and classic elegance make it a stylish piece for interiors.







Couture SB

© CVL

**Finitions  
Finishes**

 Laiton satiné	 Graphite satiné	 Nickel satiné	 Cuivre satiné	 Bronze
<b>SB</b> Satin brass	<b>SG</b> Satin graphite	<b>SN</b> Satin nickel	<b>SC</b> Satin copper	<b>BZ</b> Bronze

[Nuancier – Finish options](#)

 Laiton poli	 Graphite poli	 Nickel poli	 Cuivre poli
<b>PB</b> Polished brass	<b>PG</b> Polished graphite	<b>PN</b> Polished nickel	<b>PC</b> Polished copper

**Abat-jour  
Lampshade**

<input type="checkbox"/> Drop Paper® 100	<input type="checkbox"/> Drop Paper® 101	<input type="checkbox"/> Chinette blanche White chinette
--	--	---

**Matériaux  
Materials**

Laiton massif Solid Brass	Abat-jour Drop Paper® M1 Lampshade Drop Paper® M1	Câble textile noir (longueur ≈ 2 m) Black textile cable (length ≈ 78.7")
------------------------------	--	---

**Source  
Lamping**

1 x E14 LED 7W max. non fournie 1 x E14 LED 7W max. not included	Interrupteur sur câble Cable switch
---	--

**Designer**

Hervé Langlais

**Lampe de table – Table lamp**

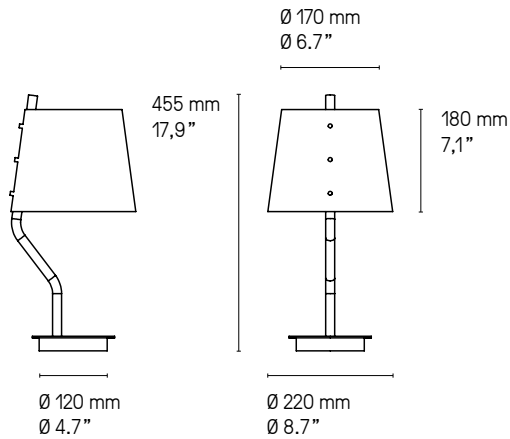

En standard, le dessous de la base sera toujours en finition graphite, si vous préférez une autre finition, merci de le préciser.

As standard, the underside of the base always comes in a satin graphite finish unless specified differently.



Lampe de table – Table lamp Couture SG



Lampe de table – Table lamp Couture SB

## NUANCIER - FINISH OPTIONS 2026



### LAITON - BRASS

① Laiton satiné SB Satin brass	② Graphite satiné SG Satin graphite	③ Nickel satiné SN Satin nickel	④ Cuivre satiné SC Satin copper	⑨ Bronze BZ Bronze
⑤ Laiton poli PB Polished brass	⑥ Graphite poli PG Polished graphite	⑦ Nickel poli PN Polished nickel	⑧ Cuivre poli PC Polished copper	

### ABAT-JOURS - LAMPSHADES



Drop Paper® 100

Drop Paper® 101

Chinette blanche  
White chinette

Chinette noire  
Black chinette

Lin  
Linen

### AUTRES - OTHERS



MA Marbre  
Marble

NO Noyer  
Walnut

TW Bois Toasté  
Toasted wood

BW Bois brûlé  
Burnt wood

### VERRERIE - GLASS



Opale  
Opal

Opale et écaille  
Opal and patterned

Claire et écaille  
Clear and patterned

### CÂBLES - CABLES



Tissu noir  
Black textile

Tissu or  
Gold textile

TEL. +33 (0) 2 41 32 67 54 EMAIL : CONTACT@CVL-LUMINAIRES.FR

[WWW.CVL-LUMINAIRES.FR](http://WWW.CVL-LUMINAIRES.FR)