

IP SIGNAL

DESIGNED BY PAULINE DELTOUR









Élégance des formes, aux accents minimalistes et aux finitions soignées. Retrouvez l'esprit CVL dans une collection d'appliques esthétiques et fonctionnelles, spécifiquement conçues pour la salle de bain.



Elegant shapes, minimalist accents and immaculate finishes. Find the CVL spirit in a collection of aesthetic and functional wall lights, specifically designed for bathrooms.



**Finitions
Finishes**

 Laiton satiné SB Satin brass	 Graphite satiné SG Satin graphite	 Nickel satiné SN Satin nickel	 Cuivre satiné SC Satin copper
 Laiton poli PB Polished brass	 Graphite poli PG Polished graphite	 Nickel poli PN Polished nickel	 Cuivre poli PC Polished copper

[Nuancier – Finish options](#)

**Matériaux
Material**

Laiton massif Solid Brass	Diffuseur polycarbonate satiné Satin Polycarbonate diffuser
------------------------------	--

**Source
Lamping**

IP Signal 375 (375 mm – 14.8")			
LED intégrée 280 lm 3 000°K 5W	Alimentation 24V intégrée	Variable (phase cut)	
Integrated LED 280 lm 3 000°K 5W	Int. power supply 24V included	Dimmable (phase cut)	
IP Signal 475 (475 mm – 18.7")			
LED intégrée 480 lm 3 000°K 7W	Alimentation 24V intégrée	Variable (phase cut)	
Integrated LED 480 lm 3 000°K 7W	Int. power supply 24V included	Dimmable (phase cut)	
IP Signal 575 (575 mm – 22.6")			
LED intégrée 670 lm 3 000°K 9W	Alimentation 24V intégrée	Variable (phase cut)	
Integrated LED 670 lm 3 000°K 9W	Int. power supply 24V included	Dimmable (phase cut)	
IP Signal double 580 (580 mm – 22.8")			
LED intégrée 570 lm 3 000°K 7W	Alimentation 24V intégrée	Variable (phase cut)	
Integrated LED 570 lm 3 000°K 7W	Int. power supply 24V included	Dimmable (phase cut)	
IP Signal double 780 (780 mm – 30.7")			
LED intégrée 960 lm 3 000°K 13W	Alimentation 24V intégrée	Variable (phase cut)	
Integrated LED 960 lm 3 000°K 13W	Int. power supply 24V included	Dimmable (phase cut)	
IP Signal double 980 (980 mm – 38.6")			
LED intégrée 1340 lm 3 000°K 17W	Alimentation 24V intégrée	Variable (phase cut)	
Integrated LED 1340 lm 3 000°K 17W	Int. power supply 24V included	Dimmable (phase cut)	

**Norme
Standard**

IP44	Classe II
IP44	Class II

Designer

Pauline Deltour

IP Signal double 980

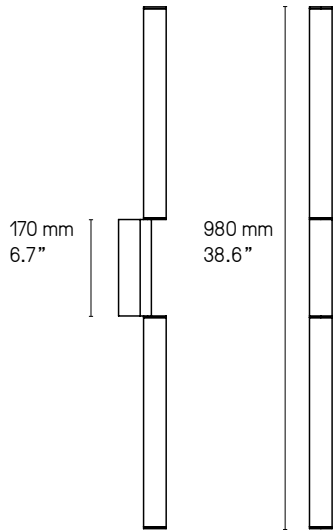

40 mm
1.57"
84 mm
3.3"

IP Signal double 780

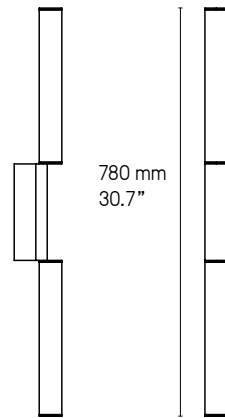

40 mm
1.57"
84 mm
3.3"

IP Signal double 580

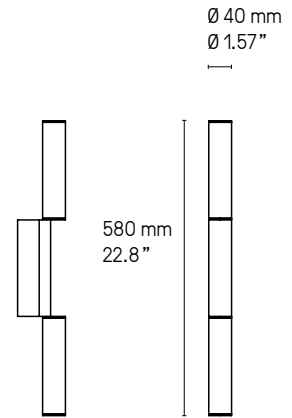

40 mm
1.57"
84 mm
3.3"

IP Signal simple 575

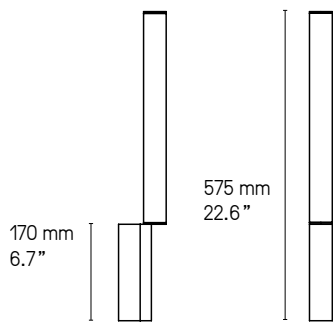

40 mm
1.57"
84 mm
3.3"

IP Signal simple 475

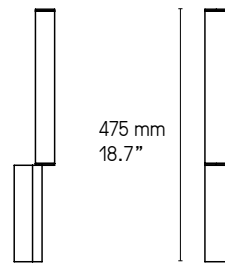

40 mm
1.57"
84 mm
3.3"

IP Signal simple 375

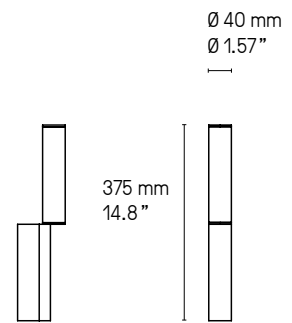

40 mm
1.57"
84 mm
3.3"

*Signal peut être installée horizontalement ou verticalement.
Signal can be placed both horizontally or vertically on the wall.*



IP Signal Double 980 SN

© Laura Evrat



IP Signal Simple 475 PN



IP Signal Simple 475 PB



© Yannick Labrousse

CVL LUMINAIRES

79 ROUTE DE LA CHEVALLERIE - 49770 LONGUENÉE-EN-ANJOU - FRANCE

TEL. +33 (0) 2 41 32 67 54

EMAIL : CONTACT@CVL-LUMINAIRES.FR

WWW.CVL-LUMINAIRES.FR

Brand identity: [POOL](#) Layout & production supervision: [deuxpointdeux](#)
Photos: [Garnier Studios](#) except when mentioned otherwise 3D: [CVL](#) except when mentioned otherwise

Make sure to download our latest catalogue [here](#)